

Roma
trick

A-Trick 1000 *Classic* User Guide

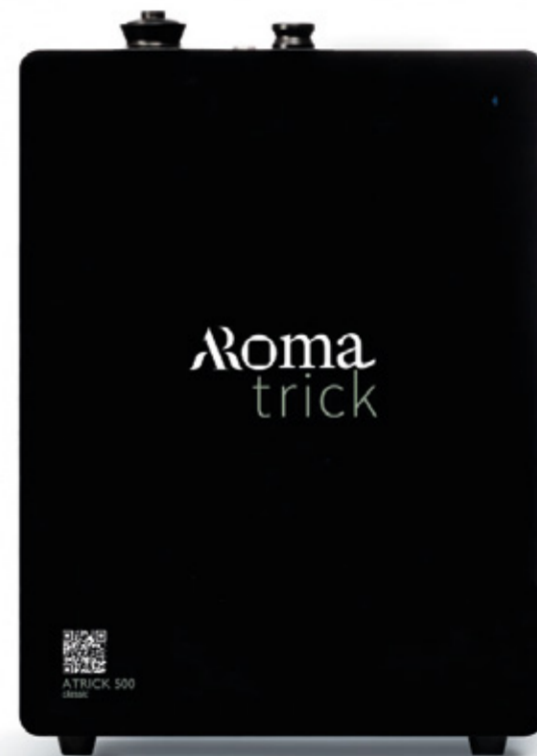

Manifest Brand Development Ltd

Company Reg. Number 13498335, VAT Number GB424451222, customercare@aromatrick.co.uk





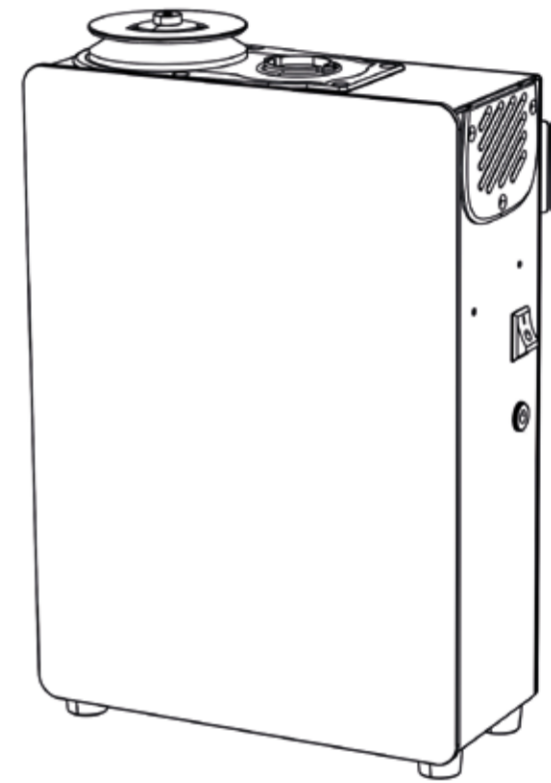

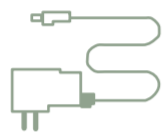

Product Specifications

| | |
|-----------------|---|
| Model | A-Trick 1000 classic |
| Dimension | 317*260*100 mm |
| Machine N.W. | 4.5 Kg |
| Voltage | DC 12V - 2A |
| Power | 5.5 W |
| Bottle Capacity | 1000 ml |
| Coverage | up to 1000 m ² /10,000 ft ² |

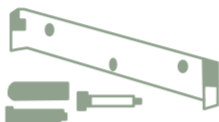

Essentials part of your product

Make sure nothing is missing from the items below:

| | | | | | | | | |
|---|---|---|--|---|---|---|---|---|
|  |  |  |  |  |  |  |  |  |
| Plug | 500 ml Bottle | PU tube | Manual | Connector | Mounting Bracket | Gasket | PTFE tape | Key |
| PTFE tape: | | <ol style="list-style-type: none"> 1. Tie up / twine the atomized core when change a new one to machine 2. Twine connector screwing to machine. | | | | | | |

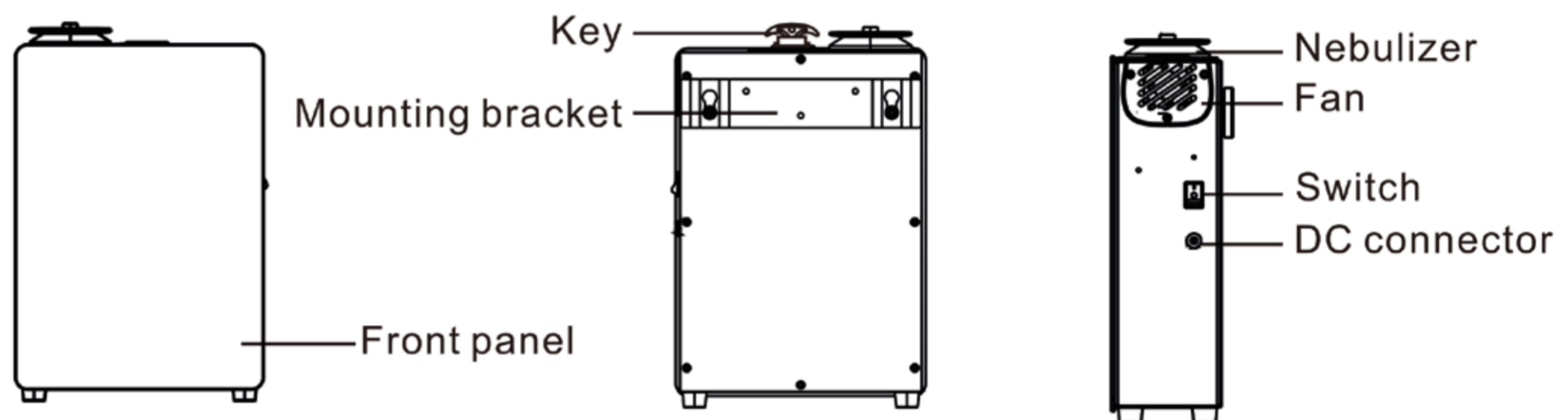

Mount to the Wall

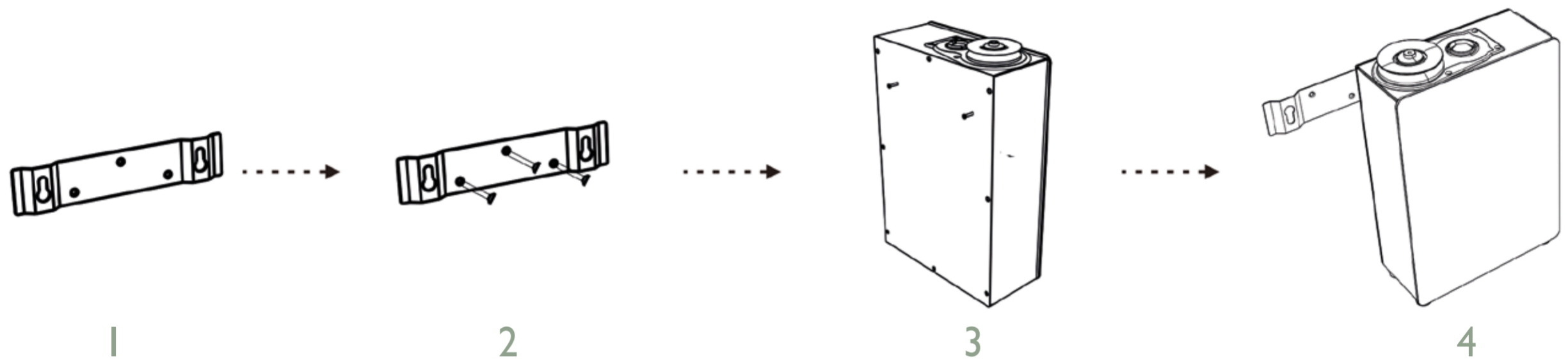

1. Align the bracket and drill holes in the wall.
2. Press the expansion tubes into the wall holes, and wall mount the bracket with screws.
3. Screw in the back of the machine.
4. Attach the machine to the bracket.

Bottle Installation Steps



1. Insert the key to release the bottle.
2. Rotate the key clockwise to unlock.
3. Unscrew and take out the atomized head, then fill with fragrance.
For the best result, leave **15% of the bottle empty** to allow enough space for mist circulation
4. Insert the atomized head and bottle.
5. Take out the key



do not tilt/turn/move
when bottle is in device

Let's get you started
by downloading the app

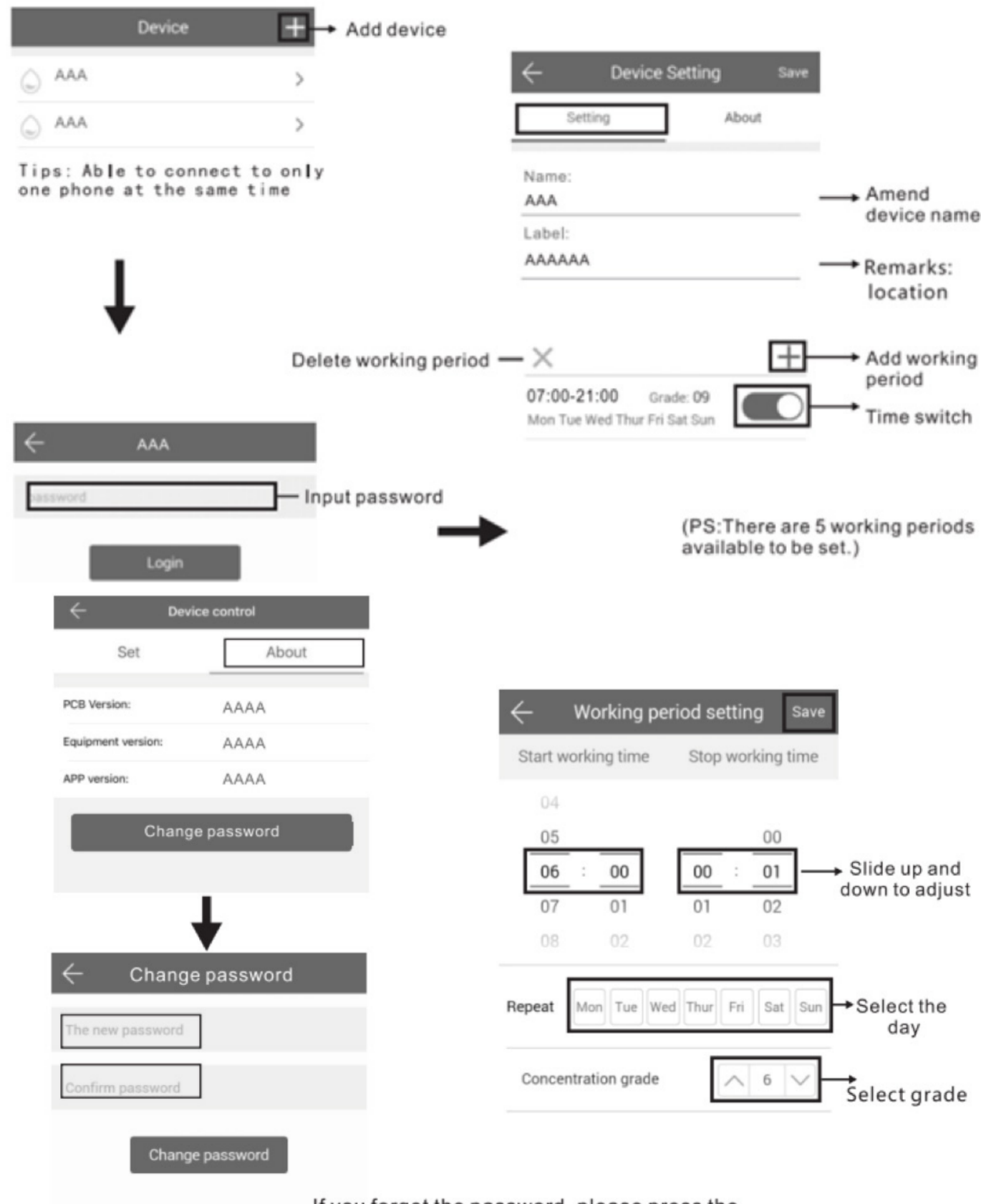

If you forget the password, please press the reset button to restore the factory settings. The factory settings password is 8888.

Boost your experience with our set-up tips

- The increase in the grade is likely to result in higher consumption.
- Our recommendation is to start by grade 8 then increase or decrease based on your preference.
- Less hours of operation results in extending the life of the bottle.
- We recommend to operate the aroma device for half an hour before the activity/the event begins

Caution



Shall not modify, disassemble or repair the machine arbitrarily. vv



Shall not damage the power cord, force to bend, yank, heavy load, clip or reprocess.



- o Shall not use the AC plug when it is damaged or un-matched with the socket.
- o Shall not wet the machine or the AC plug.
- o Shall not use overloaded power socket, wire or broken plug.



Shall not touch the wire or product shell when thundering or/and lightening.



Shall not disassemble the machine when it is under operation.

For any inquiry, please contact our live installation assistant



Warning:

- After installation, please keep the machine vertical, tilting the machine flat will cause oil leakage and damage to the machine.
- Do not refit, disassemble or repair the machine if you are not a technician. If the machine breaks down, please contact our customer care for help customercare@aromatrick.co.uk
- It is invalid to touch/tap the digital timer button when machine is under lock status.
- Each time cycle should be between (00:01 until 23:59), if you need your device to operate throughout the night time, make sure you divide the operation time to **two cycles**.

TROUBLESHOOTING

Before asking to have the machine repaired, please try to diagnose the problem first following the instructions below:

| Symptom | Remedy |
|------------------|--|
| Does not diffuse | <ul style="list-style-type: none"> • Check the power is on or off • if the machine is in “not working period”, it stops diffuse. • the pump is damages, change a new one. |
| Spray little | <ul style="list-style-type: none"> • Atomized nozzle may be blocked, diffuse with alcohol to do cleaning. • pump is aging, change a new one. |
| Spray liquid | <ul style="list-style-type: none"> • Atomized nozzle is damaged, change a new one. • machine is tilted or lay flat, please make it stand on end. |
| Oil spill | <ul style="list-style-type: none"> • bottle is loose, screw it to the right place. |
| Abnormal sound | <ul style="list-style-type: none"> • Pump is loose, install it correctly. |

- If the machine programs crashes or other abnormal condition occurs, please restart the machine to restore factory setting (method: press ENT key about 5 minutes until you hear “beep” sound)

CLEANING DIFFUSER

Diffuser should be cleaned regularly, timing recommendation below:

1. Refilling/ changing fragrance in reservoir.
2. Scenting strength becomes weak.

- Turn off Scenting Diffuser before cleaning.
- Place clean bottle with small quantity of “Methylated Spirits”/ Industrial alcohol.
- Turn on Machine and let diffuse for 5 minutes.
- Turn off power and unscrew cleaning fluid bottle.
- Replace with fresh fragrance, machine is now ready for diffusing.

Roma
trick